

EP585H

# Bravetti™

## ONE (1) YEAR LIMITED WARRANTY

**EURO-PRO OPERATING LLC** warrants this product to be free from defects in material and workmanship for a period of one (1) year from the date of purchase when utilized for normal household use.

If your appliance fails to operate properly while in use under normal household conditions within the warranty period, return the complete appliance and accessories, freight prepaid to **EURO-PRO Operating LLC**, 94 Main Mill Street, Door 16, Plattsburgh, N.Y. 12901. If the appliance is found to be defective in material or workmanship, **EURO-PRO Operating LLC** will repair or replace it free of charge. Proof of purchase date and \$12.95 to cover the cost of return shipping and handling must be included.\*

The liability of **EURO-PRO Operating LLC** is limited solely to the cost of the repair or replacement of the unit at our option. This warranty does not cover normal wear of parts and does not apply to any unit that has been tampered with or used for commercial purposes. This limited warranty does not cover damage caused by misuse, abuse, negligent handling or damage due to faulty packaging or mishandling in transit.

This warranty is extended to the original purchaser of the unit and excludes all other legal and/or conventional warranties. The responsibility of **EURO-PRO Operating LLC** if any, is limited to the specific obligations expressly assumed by it under the terms of the limited warranty. **In no event** is **EURO-PRO Operating LLC** liable for incidental or consequential damages of any nature whatsoever. Some states do not permit the exclusion or limitation of incidental or consequential damages, so the above may not apply to you.

This warranty gives you specific legal rights, and you may also have other rights which vary from state to state.

**\*Important: Carefully pack item to avoid damage in shipping. Be sure to include proof of purchase date and to attach tag to item before packing with your name, complete address and phone number with a note giving purchase information, model number and what you believe is the problem with item. We recommend you insure the package (as damage in shipping is not covered by your warranty). Mark the outside of your package "ATTENTION CUSTOMER SERVICE". We are constantly striving to improve our products, therefore the specifications contained herein are subject to change without notice.**



### OWNERSHIP REGISTRATION CARD

Please fill out and mail the product registration card within ten (10) days of purchase. The registration will enable us to contact you in the unlikely event of a product safety notification. By returning this card you acknowledge to have read and understood the instructions for use, and warnings set forth in the accompanying instructions.

RETURN TO **EURO-PRO OPERATING LLC**, 94 Main Mill Street, Door 16, Plattsburgh, N.Y. 12901

EP585H

Appliance model

Date purchased

Name of store

Owner's name

Address

City

State

Zip Code

# Bravetti™

## CONVERTIBLE HAND/STAND MIXER

### OWNER'S MANUAL

Model EP585H  
127V., 60Hz., 325 Watts



For information or assistance:

**EURO-PRO Operating LLC**

94 Main Mill Street, Door 16

Plattsburgh, NY 12901

Tel.: 1 (800) 798-7398

**EURO-PRO**

# IMPORTANT SAFETY INSTRUCTIONS

When using electrical appliances, basic safety precautions should always be followed, including the following:

1. Read all instructions for use carefully and look at the illustrations before you start using the appliance.
2. To protect against risk of electrical shock, **do not** immerse power cord, plug or mixer in water or any other liquid.
3. Close supervision is necessary when any appliance is used by or near children.
4. **Unplug** from outlet when not in use, before putting on or taking off parts and before cleaning the appliance.
5. **Do not** operate any appliance with a damaged cord or plug, or after the appliance malfunctions, has been dropped or damaged in any manner. Return the appliance to **EURO-PRO Operating LLC** for examination, repair or adjustment. See warranty.
6. Avoid contact with moving parts at all times. Keep hands, hair, clothing, as well as spatulas and other utensils away from beaters during operation to prevent personal injury and/or damage to the mixer.
7. The use of accessory attachments not recommended by the appliance manufacturer may cause injuries.
8. Remove beaters and dough hooks from mixer before cleaning.
9. **NEVER** place the unit close to the edge of a counter or table. Make sure that the power cord is positioned safely so that nobody trips or gets tangled in it.
10. **Extreme** caution must be used when moving any appliance containing hot liquids.
11. **Do not** leave appliance unattended while in use.
12. **Do not** use outdoors.
13. **Do not** let cord hang over the edge of the table, counter or touch hot surfaces.
14. **Do not** place on or near a hot gas or electric burner, or in a heated oven.
15. **Do not** use appliance for other than intended household use.
16. To avoid injury by accidentally switching on the appliance when inserting the beaters or dough hooks, always set the switch to the "OFF" position and unplug the appliance before assembling or disassembling.

**Note:** An extension cord may be used if you are careful in its use:

1. The electrical rating of the extension cord should be at least as great as the electrical rating of the appliance.
2. An extension cord with the power cord must be arranged so that it will not drape over the countertop or tabletop where they can be pulled on by children or tripped over accidentally.

This appliance has a polarized plug (one blade is wider than the other). To reduce the risk of electric shock, this plug is intended to fit into a polarized outlet only one way. If the plug does not fit fully into the outlet, reverse the plug. If it still does not fit, contact a qualified electrician. Do not attempt to modify the plug in any way.

## SAVE THESE INSTRUCTIONS FOR HOUSEHOLD USE ONLY

## CARE & CLEANING

- Warning:** Before cleaning your Hand/Stand Mixer, ensure that the power is turned off and that the power cord is not plugged into the electrical outlet. Always switch off and unplug before cleaning.
1. Wipe the outside area of the Hand/Stand Mixer with a damp cloth and polish with a soft, dry cloth. **NEVER** immerse the hand mixer, stand, plug or power cord into water or any other liquid.
  2. Wipe any excess food particles from the power cord.
  3. To make cleaning easier, remove beaters/dough hooks and wash right away after use. Wash the mixing bowl, beaters and dough hooks in warm, soapy water. The stainless steel mixing bowl, beaters and dough hooks are dishwasher safe. The plastic bowl, bowl lid and spatula are top rack dishwasher safe **ONLY**. Do **NOT** use scouring pads, harsh detergents or abrasive cleaners to clean the bowls, beaters or dough hooks. Dry with a soft, clean cloth.

### Storing Your Hand/Stand Mixer

You can keep your Hand/Stand Mixer in a convenient place on your kitchen counter ready for use. Place the beaters and dough hooks into the bowl. Storing the beaters or dough hooks in a drawer with other kitchen utensils may cause damage.

Never wind the power cord around the motor after use as the warmth of the motor may cause damage to the power cord.

## IMPORTANT INSTRUCTIONS

| ALWAYS   | NEVER  |
|--|--|
| <b>ALWAYS</b> make sure that your hands are dry before handling the plug or switching on the appliance.  | <b>NEVER</b> place your hand in the bowl while it is in operation.   |
| <b>ALWAYS</b> use the mixer on a dry, level surface.   | <b>NEVER</b> use this appliance outdoors.  |
| <b>ALWAYS</b> unplug unit from the electrical outlet when not in use or when removing attachments and before cleaning.   | <b>NEVER</b> use this appliance for other than for intended use. This appliance is for household use only.   |
| <b>ALWAYS</b> remove the beaters or dough hooks from the mixer before washing.   | <b>NEVER</b> mix dry, thick or heavy mixture for more than 60 seconds without turning off the hand mixer and stirring the ingredients before continuing. |
| <b>ALWAYS</b> avoid contact with moving parts while unit is in operation. Keep hands, hair, clothing as well as other utensils away from beaters/dough hooks during operation. | <b>NEVER</b> use harsh, abrasive or caustic cleansers to clean this appliance.   |
|  | <b>NEVER</b> allow children to use this appliance unsupervised.  |
|  | <b>NEVER</b> leave this appliance unattended while in use.   |
|  | <b>NEVER</b> let the power cord to hang over the edge of a table or counter, touch hot surface or become knotted.  |
|  | <b>NEVER</b> eject attachments with the unit operating.  |

## OPERATING INSTRUCTIONS

### Fitting the Bowl onto the Turntable of the Stand

**Warning:** To avoid injury when assembling the hand mixer to the stand, always set the speed selector on “0” and unplug the appliance.

1. Place the base of the mixing bowl onto the turntable of the stand. To fully lock the mixing bowl in place, press down and turn the mixing bowl in a clockwise direction until you hear it click into place. (Fig. 9)

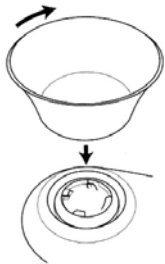

Fig. 9

2. To remove the mixing bowl from the stand, press down and turn the mixing bowl counter clockwise. The mixing bowl can now be detached from the turntable and lifted away. (Fig. 10)

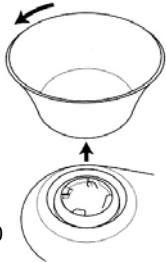

Fig. 10

**Note:** It is easier to fit the mixing bowl to the turntable when the hand mixer is not attached to the pivot support.

### Using the Convertible Hand/Stand Mixer

**Warning:** To avoid injury when assembling the hand mixer to the stand, always set the speed selector on “0” and unplug the appliance.

1. Before plugging the hand/stand mixer into the electrical outlet, assemble the unit with the desired accessories.
2. Set the speed selector switch to the “HI” or “LO” position.
3. Select the speed that you desire.

| MIXING GUIDE        |                      |
|---------------------|----------------------|
| MIXING TASK         | RECOMMENDED SPEED(S) |
| Folding & Blending  | “LO” 1 & 2           |
| Light Mixing        | “LO” 3 & 4           |
| Creaming & Beating  | “HI” 6 - 8 or “LO” 5 |
| Whipping & Aerating | “HI” 9 & 10 or BURST |

4. Select the bowl speed – “LO” or “HI” depending on how fast you want the bowl to turn. Use the “LO” bowl speed for mixing speed 1-5. Use the “HI” bowl speed for mixing speed 6-10. If you do not wish the bowl to turn, leave the bowl speed in the “OFF” position.

#### Note:

- Always select the speed setting before the mixing bowl speed to prevent ingredients from being flicked out of the mixing bowl.
- Always start mixing at slow speeds and increase the speed gradually to prevent the ingredients splashing out of the bowl.

## GETTING TO KNOW YOUR CONVERTIBLE HAND/STAND MIXER

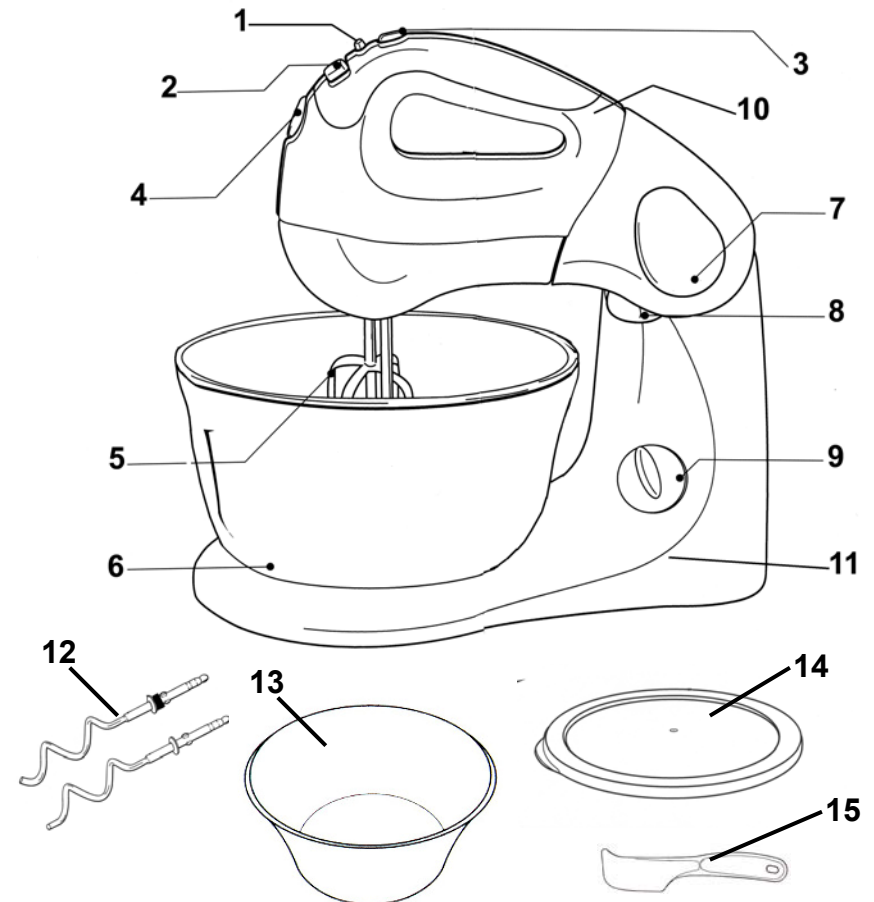

- |                              |                            |
|------------------------------|----------------------------|
| 1. Hi-Lo Speed Selector      | 9. Bowl Speed Control Dial |
| 2. Speed Control             | 10. Hand Mixer             |
| 3. Burst of Speed Button     | 11. Base Stand             |
| 4. Beater Eject Button       | 12. Dough Hooks            |
| 5. Beaters                   | 13. Plastic Bowl           |
| 6. Stainless Steel Bowl      | 14. Bowl Lid               |
| 7. Tilt Button               | 15. Spatula                |
| 8. Hand Mixer Release Button |                            |

### Technical Specifications

|                |              |
|----------------|--------------|
| Voltage:       | 127V., 60Hz. |
| Power:         | 325Watts     |
| Bowl Capacity: | 3.5 Qts.     |

## OPERATING INSTRUCTIONS

**Warning:** To avoid injury when inserting or removing beaters or dough hooks, always set the speed selector on “0” and unplug the appliance.

- Before using your **Bravetti Convertible Hand/Stand Mixer** for the first time, wash the beaters, dough hooks, bowls and spatula in warm, sudsy water. Rinse and dry thoroughly. Use a damp cloth to wash over the mixer base and the hand mixer. Dry with a soft cloth. NEVER immerse the base stand or the hand mixer in water or any other liquids.
- Before assembling your Convertible Hand/Stand Mixer, make sure that the power cord is unplugged from the electrical outlet and that both the speed control and the base speed control dial are in the “OFF” position.

### Attaching the Beaters to the Hand Mixer

- Ensure that the hand mixer is not plugged in to an electrical outlet and that the speed control switch is on the “0” (off) position.
- Insert the beaters into the sockets on the under side of the hand mixer and twist counter clockwise until the beater is firmly fitted into the socket.
- To release the beaters from the unit, press on the beater eject button on the front of the unit and they will pop out. (Fig. 1)

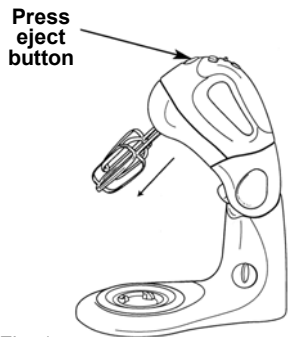

Fig. 1

### Attaching the Dough Hooks to the Hand Mixer

- Ensure that the hand mixer is not plugged in to an electrical outlet and that the speed control switch is on the “0” (off) position.
- The dough hooks have a set method of fitting into the hand mixer because they are not identical. One has a grommet and the other does not. (Fig. 2)

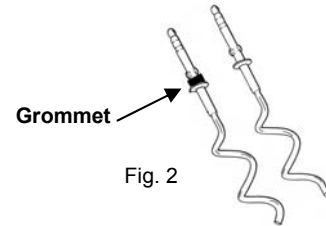

Fig. 2

- Looking at the under side of the hand mixer, you will see that one of the sockets has a red dot over it. (Fig. 3) Insert the dough hook with the grommet into this socket.

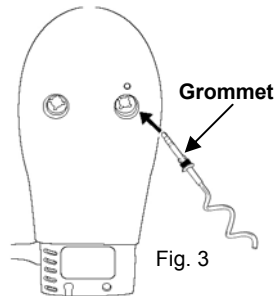

Fig. 3

- Then insert the other dough hook into the other socket. Push both dough hooks in until you hear a click confirming that they are securely in place.
- To release the dough hooks from the unit, press on the beater eject button on the front of the unit and they will pop out. (Fig. 1)

**Note:** Ensure that the beaters or dough hooks are fully inserted into the correct sockets or your mixing results may be affected.

## OPERATING INSTRUCTIONS

### Assembling the Hand Mixer to the Stand

**Warning:** To avoid injury when assembling the hand mixer to the stand, always set the speed selector on “0” and unplug the appliance.

- Press the tilt button, located on the top of the support pivot. While the button is depressed, ease the support pivot back. (Fig. 4)

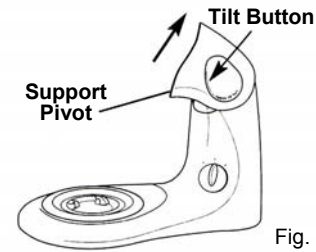

Fig. 4

The support pivot will lock into this raised position until it is released by pressing the tilt button again.

- To connect the hand mixer to the support pivot into the two retaining prongs on the support pivot into the two rectangular holes in the heel of the hand mixer. (Fig. 5) When the hand mixer is seated on the support pivot, press down on the hand mixer to click it into place and lock the hand mixer and the support pivot together.

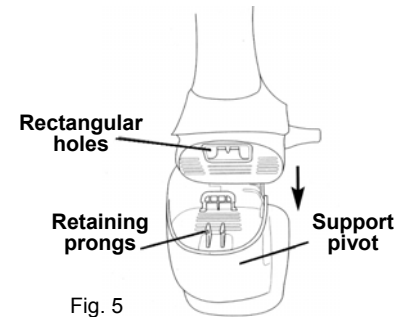

Fig. 5

**Note:** Ensure that the two retaining prongs on the support pivot are fully connected into the hand mixer.

- While the hand mixer is still in the raised position, insert either the beaters or the dough hooks.
- To lower the hand mixer, press and hold the tilt button with one hand while holding the hand mixer with the other hand and slowly lower the hand mixer down. (Fig. 6)

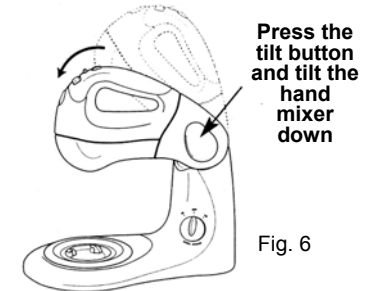

Fig. 6

- To remove the hand mixer from the pivot support, first raise the mixer by pressing the tilt button and raise the mixer up. (Fig. 7) the mixer will lock into the raised position.
- Then press the mixer release button which is located on the under side of the pivot support with one hand and with the other lift the hand mixer by the handle upwards and away from the support pivot. (Fig. 8)

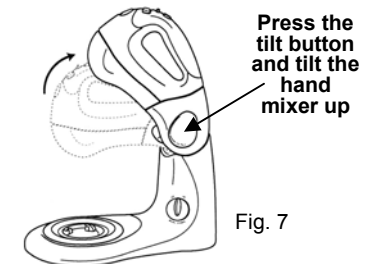

Fig. 7

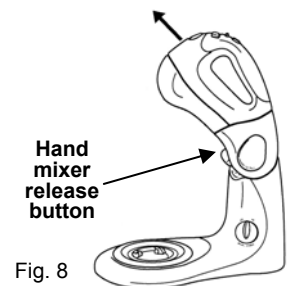

Fig. 8